

SIRUBA®

銀爺牌工業用縫紉機

INDUSTRIAL SEWING MACHINE

VC008

零件圖 PARTS LIST

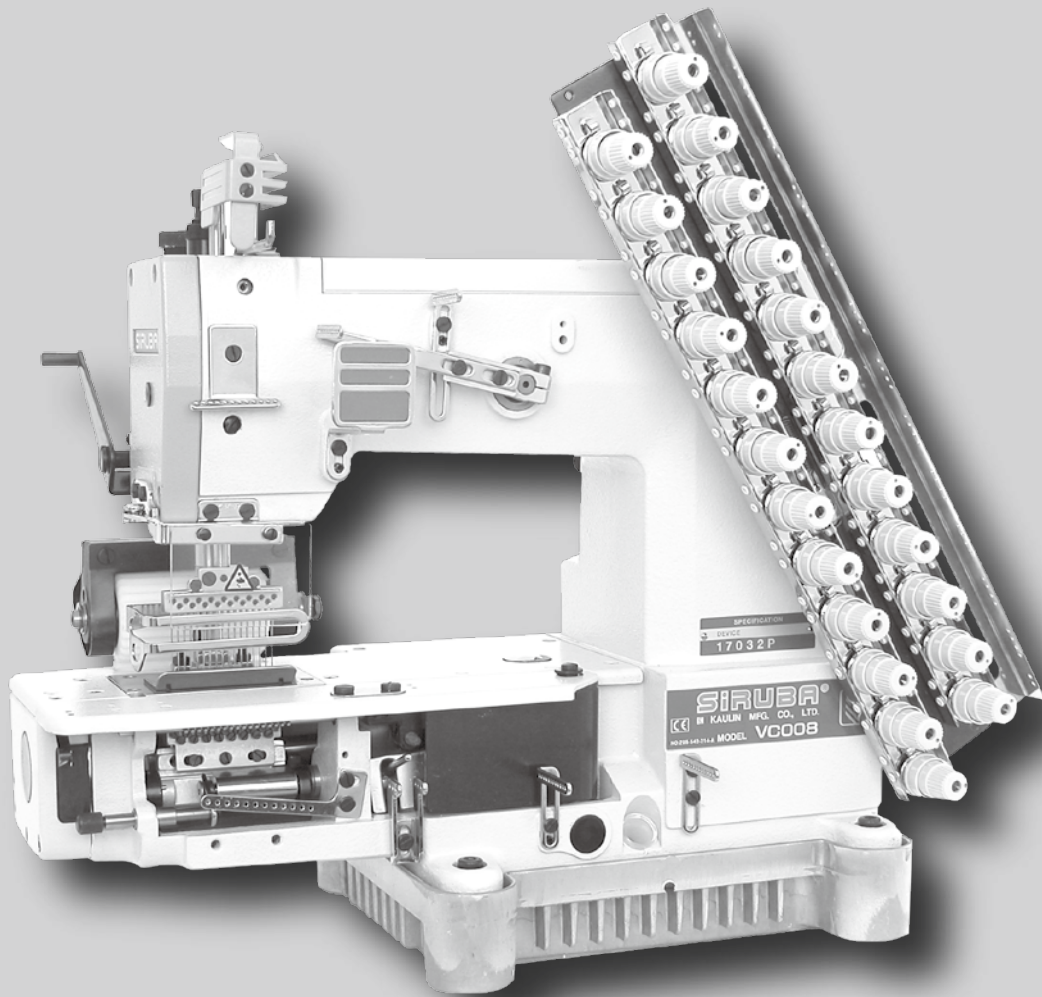

CE







高林股份有限公司
KAULIN MFG. CO., LTD.

機 型 MODEL	規 格 SVB CLASS	種 類 NEEDLE GAUGE	針 座 NEEDLE HOLDER	針 板 NEEDLE PLATE	送 具 FEED DOG	押 具 PRESSER FOOT	撥 線 軸 RETAINER HOLDER	勾 針 LOOPER	護 針 片 NEEDLE GUARD	勾 針 座 LOOPER HOLDER	勾 針 座 台 LOOPER HOLDER BLOCK	針 號 NEEDLE
VC008-02/VMR	064P	1/4"										
	064P	3/4"	GM9004	E9004D	D9004	P9004	R9004	VE51	VE49	L9004	VE11Q	Uo113 #11~14
	085P	1"	GM9104	E9104D	D9104	P9104	R9104	VE51	VE49	L9104	VE11	Uo113 #11~14
	095P	1 1/8"	GM9204	E9204D	D9204	P9204	R9204	VE51	VE49	L9204	VE11Q	Uo113 #11~14
VC008-04	106P	1 1/4"	GM9304	E9304D	D9304	P9304	R9304	VE51	VE49	L9304	VE11Q	Uo113 #11~14
	127P	1 1/2"	GM9404	E9404D	D9404	P9404	R9404	VE51	VE49	L9404	VE11Q	Uo113 #11~14
	064P	3/4"	GM9004	E9004D	D9004	P9004	R9004	VE51	VE49	L9004	VE11Q	Uo113 #11~14
	085P	1"	GM9104	E9104D	D9104	P9104	R9104	VE51	VE49	L9104	VE11	Uo113 #11~14
VC008-04/VCE /RL/VAD	095P	1 1/8"	GM9204	E9204D	D9204	P9204	R9204	VE51	VE49	L9204	VE11Q	Uo113 #11~14
	106P	1 1/4"	GM9304	E9304D	D9304	P9304	R9304	VE51	VE49	L9304	VE11Q	Uo113 #11~14
	127P	1 1/2"	GM9404	E9404D	D9404	P9404	R9404	VE51	VE49	L9404	VE11Q	Uo113 #11~14

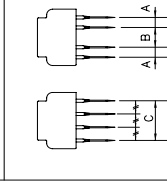
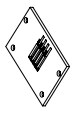
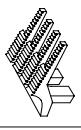
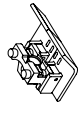
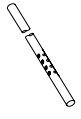
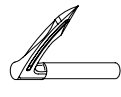
規格件表 CONVERSION CHART

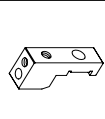
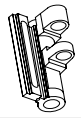
規格件表 CONVERSION CHART







機 型 MODEL	規 格 SVB CLASS	種 類 NEEDLE GAUGE	 針 座 NEEDLE HOLDER	 針 板 NEEDLE PLATE	 送 具 FEED DOG	 押 具 PRESSER FOOT	 撥 線 軸 RETAINER HOLDER	 勾 針 LOOPER	 護 針 片 NEEDLE GUARD	 勾 針 座 LOOPER HOLDER	 勾 針 座 台 LOOPER HOLDER BLOCK	 針 號 NEEDLE
VC008-04/VCE /RL/VAD/VUT	064P	3/4"	GM9004	E9004D	D9004P	P9004	VUT109P	VE51	VE49	L9004	VE11Q	Uo113 #11~14
	085P	1"	GM9104	E9104D	D9104P	P9104	VUT109P	VE51	VE49	L9104	VE11	Uo113 #11~14
	095	1 1/8"	GM9204	E9204D	D9204P	P9204	VUT109P	VE51	VE49	L9204	VE11Q	Uo113 #11~14
VC008-04/VCE /RL/VAD/VUT	106P	1 1/4"	GM9304	E9304D	D9304P	P9304	R9304	VE51	VE49	L9304	VE11Q	Uo113 #11~14
	127P	1 1/2"	GM9404	E9404D	D9404P	P9404	R9404	VE51	VE49	L9404	VE11Q	Uo113 #11~14
	064P	3/4"	GM9004	E9004D	D9004	P9004	R9004	VE51	VE49	L9004	VE11Q	Uo113 #11~14
VC008-04/VWL /FH	085P	1"	GM9104	E9104D	D9104	P9104	R9104	VE51	VE49	L9104	VE11	Uo113 #11~14
	095P	1 1/8"	GM9204	E9204D	D9204	P9204	R9204	VE51	VE49	L9204	VE11Q	Uo113 #11~14
	106P	1 1/4"	GM9304	E9304D	D9304	P9304	R9304	VE51	VE49	L9304	VE11Q	Uo113 #11~14
VC008-04/VWL /FH	127P	1 1/2"	GM9404	E9404D	D9404	P9404	R9404	VE51	VE49	L9404	VE11Q	Uo113 #11~14
	064P	3/4"	GM9004	E9004D	D9004P	P9004	VUT109P	VE51	VE49	L9004	VE11Q	Uo113 #11~14
	085P	1"	GM9104	E9104D	D9104P	P9104	VUT109P	VE51	VE49	L9104	VE11	Uo113 #11~14

機 型 MODEL	規 格 SVB CLASS	種 類 NEEDLE GAUGE	針 座 NEEDLE HOLDER		針 板 NEEDLE PLATE	送 具 FEED DOG	押 具 PRESSER FOOT	撥 線 軸 RETAINER HOLDER	勾 針 LOOPER	護 針 片 NEEDLE GUARD	勾 針 座 LOOPER HOLDER	勾 針 座 台 LOOPER HOLDER BLOCK	針 號 NEEDLE
			針 座 NEEDLE HOLDER	針 座 NEEDLE HOLDER									
VC008-04/VUT	095P	1 1/8"	GM9204		E9204D	D9204P	P9204	VUT109P	VE51	VE49	L9204	VE11Q	Uo113 #11~14
	106P	1 1/4"	GM9304		E9304D	D9304P	P9304	VUT109P	VE51	VE49	L9304	VE11Q	Uo113 #11~14
	127P	1 1/2"	GM9404		E9404D	D9404P	P9404	VUT109P	VE51	VE49	L9404	VE11Q	Uo113 #11~14
VC008-04A	64P	1/4"	GM9213		E9213	D9213	P9213D	R9213	VE51	VE49	L9002	VE11Q	Uo113*4 #11~#14
	032P	(1/4-1/8-1/8 1/4)*3	GM9113		E9113	D9113	P9113D	R9113	VE51T	VE49T	L9119T-E	VE11Q	Uo113 #11~#14
VC008-0448	191P	3/16-3/4-3/16"		GM9504A	E9504E	D9504A	P9504A	R9504A	VE51	VE49	L9504A	VE11Q	Uo113 #11~14
	222P	3/16-7/8-3/16"		GM9204A	E9204E	D9204A	P9204A	R9204A	VE51	VE49	L9204A	VE11Q	Uo113 #11~14
	254P	3/16-1-3/16"		GM9404A	E9404E	D9404A	P9404A	R9404A	VE51	VE49	L9404A	VE11Q	Uo113 #11~14
VC008-0448 /VSF/FH	254P	3/16-1-3/16"		GM9404A	E9404E	D9404A	P9404A	R9404A	VE51	VE49	L9404A	VE11Q	Uo113 #11~14
	191P	1/4-3/4-1/4"		GM9304A	E9304E	D9304A	P9304A	R9304A	VE51	VE49	L9304A	VE11Q	Uo113 #11~14
VC008-0464	127P	1/4-1/2-1/4"		GM9004A	E9004E	D9004A	P9004A	R9004A	VE51	VE49	L9004A	VE11Q	Uo113 #11~14
	254P	1/4-1-1/4"		GM9104A	E9104E	D9104A	P9104A	R9104A	VE51	VE49	L9104A	VE11Q	Uo113 #11~14

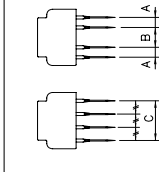
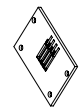
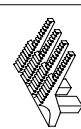
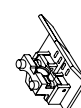
*VPT: 適用於 VC008-12XXX VSF: 適用於 VC008-0448/0464 VWL: 適用於 VC008-04XXX

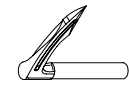
規格件表 CONVERSION CHART

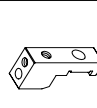
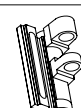
規格件表 CONVERSION CHART

機 型 MODEL	規格 SVB CLASS	種 類 NEEDLE GAUGE	 針 座 NEEDLE HOLDER	 針 板 NEEDLE PLATE	 送 具 FEED DOG	 押 具 PRESSER FOOT	 撥 線 軸 RETAINER HOLDER	 勾 針 LOOPER	 護 針 片 NEEDLE GUARD	 勾 針 座 LOOPER HOLDER	 勾 針 座 台 LOOPER HOLDER BLOCK	 針 號 NEEDLE
VC008-0464 /VSF/FH	191P	1/4-3/4-1/4"	GM9304A	E9304E	D9304A	P9304A	R9304A	VE51	VE49	L9304A	VE11Q	Uo113 #11~14
	254P	1/4-1-1/4"	GM9104A	E9104E	D9104A	P9104A	R9104A	VE51	VE49	L9104A	VE11Q	Uo113 #11~14
VC008-06/VPL /LSA	048P	3/16"	GM9012	E9012	D9012	P9412D	R9012	VE51	VE49	L9012	VE11P	Uo113 #11~14
	064P	1/4"	GM9112	E9112	D9112	P9512D	R9112	VE51	VE49	L9112	VE11P	Uo113 #11~14
VC008-06/VPL	064P	1/2"	GM9112	E9112	D9112	P9512B	R9112	VE51	VE49	L9112	VE11P	Uo113 #11~14
VC008-06/VUT	064P	1/4"	GM9112	E9112	D9112	P9512D	VUT109P	VE51	VE49	L9112	VE11P	Uo113 #11~14
VC008-06/VWL /FH	048P	3/16"	GM9012	E9012	D9012	P9412D	R9012	VE51	VE49	L9012	VE11Q	Uo113 #11~14
	048P	3/16"	GM9012	E9012	D9012	P9012D	R9012	VE51	VE49	L9012	VE11Q	Uo113 #11~14
VC008-12	050P	5mm	GM9612	E9612	D9612	P9612D	R9612	VE51	VE49	L9612	VE11Q	Uo113 #11~14
VC008-12/VPQ	064P	1/4"	GM9112	E9112	D9112	P9112D	R9112	VE51	VE49	L9112	VE11Q	Uo113 #11~14
	064P	1/4"	GM9112	E9312	D9312	P9312	R9112	VE51Q	VE49	L9112	VE11Q	Uo113 #11~14
	048P	3/16"	GM9012	E9212	D9212	P9212	R9012	VE51Q	VE49	L9012	VE11Q	Uo113 #11~14

機 型 MODEL	規 格 SVB CLASS	種 類 NEEDLE GAUGE	針 座 NEEDLE HOLDER	針 板 NEEDLE PLATE	送 具 FEED DOG	押 具 PRESSER FOOT	撥 線 軸 RETAINER HOLDER	勾 針 LOOPER	護 針 片 NEEDLE GUARD	勾 針 座 LOOPER HOLDER	勾 針 座 台 LOOPER HOLDER BLOCK	針 號 NEEDLE
VC008-12/VPQK	064P	1/4"	GM9112	E9312	D9312	P9312	R9112	VE51Q	VE49	L9112	VE11Q	Uo113 #11~14
	048P	3/16"	GM9012	E9212	D9212	P9212	R9012	VE51Q	VE49	L9012	VE11Q	Uo113 #11~14
VC008-12/VPS	048P	3/16"	GM9012	E9212A	D9212	P9212B	—	VSM47	—	L9012	VE11Q	DV-K25 #18.#21
	064P	1/4"	GM9112	E9312A	D9312	P9312B	—	VSM47	—	L9112	VE11Q	DV-K25 #18.#21
VC008-12/VPL	064P	1/4"	GM9112	E9112	D9112	P9712D	R9112	VE51	VE49	L9112	VE11Q	Uo113 #11~14
	048P	3/16"	GM9012	E9012	D9012	P9012D	R9012	VE51	VE49	L9012	VE11Q	Uo113 #11~14
VC008-12/VPT	064P	1/4"	GM9112	E9112	D9112	P9112D	R9112	VE51	VE49	L9112	VE11Q	Uo113 #11~14
	048P	3/16"	GM9012	E9012	D9012	P9012B P9212B	R9012	VE51	VE49	L9012	VE11Q	DVx57 #11~#18
VC008-12/VSM	064P	1/4"	GM9112	E9112	D9112	P9112B P9312B	R9112	VE51	VE49	L9112	VE11Q	DVx57 #11~#18
	048P	3/16"	GM9012	E9212A	D9212	P9212B	—	VSM47	VE49	L9012	VE11Q	DV-K25 #18.#21
VC008-12/VSQ	064P	1/4"	GM9112	E9312A	D9312	P9312B	—	VSM47	VE49	L9112	VE11Q	DV-K25 #18.#21
	048P	3/16"	GM9012	E9212A	D9212	P9212B	—	VSM47	VE49	L9012	VE11Q	DV-K25 #18.#21

*VPPT: 適用於 VC008-12XXX VSF: 適用於 VC008-0448/0464 VWL: 適用於 VC008-04XXX

規格件表 CONVERSION CHART

規格件表 CONVERSION CHART

機 型 MODEL	規 格 SVB CLASS	種 類 NEEDLE GAUGE	針 座 NEEDLE HOLDER		針 板 NEEDLE PLATE	送 具 FEED DOG	押 具 PRESSER FOOT	撥 線 軸 RETAINER HOLDER	勾 針 LOOPER	護 針 片 NEEDLE GUARD	勾 針 座 LOOPER HOLDER	勾 針 座 台 LOOPER HOLDER BLOCK	針 號 NEEDLE
			針 座 NEEDLE HOLDER	針 座 NEEDLE HOLDER									
VC008-12/VUT	050P	5mm	GM9612	E9612	D9612P	P9612D	VUT109P	VE51	VE49	L9612	VE11Q	Uo113 #11~#14	
VC008-12/VWL /FH	064P	1/4"	GM9112	E9112	D9112	P9112D	R9112	VE51	VE49	L9112	VE11Q	Uo113 #11~#14	
VC008-12A32	032P	(1/4-1/8-1/8 1/4)*3	GM9113	E9113	D9113	P9113D	R9113	VE51T	VE49T	L9119T-E	VE11Q	Uo113 #11~#14	
VC008-12A	64P	1/4"	GM9213	E9213	D9213	P9213D	R9213	VE51	VE49	L9002	VE11Q	Uo113*6 #11~#14	
VC008-13	032P	1/8"	GM9313	E9313	D9313	P9313	R9313	VE51T	VE49T	L9113T-E	VE11P	Uo113*4 #11~#14	
	064P	1/4"	GM9213	E9213	D9213	P9213D	R9213	VE51	VE49	L9213	VE11Q	Uo113*4 #11~#14	
VC008-1332	032P	(1/4-1/8-1/8 1/4)*3	GM9113	E9113	D9113	P9113D	R9113	VE51T	VE49T	L9119T-E	VE11P	Uo113*4 #11~#14	
VC008-17	032P	1/8"	GM9117	E9117	D9117	P9117	R9117	VE51T	VE49T	L9119T-E	VE11P	Uo113*4 #11~#14	
VC008-21	032P	1/8"	GM9121	E9121	D9121	P9121	R9121	VE51T	VE49T	L9123T-E	VE11P	Uo113*4 #11~#14	
VC008-23	032P	1/8"	GM9123	E9123	D9123	P9123	R9123	VE51T	VE49T	L9123T-E	VE11P	Uo113*4 #11~#14	
VC008-25	032P	1/8"	GM9125	E9125	D9125	P9125	R9125	VE51T	VE49T	L9125T-E	VE11P	Uo113*4 #11~#14	

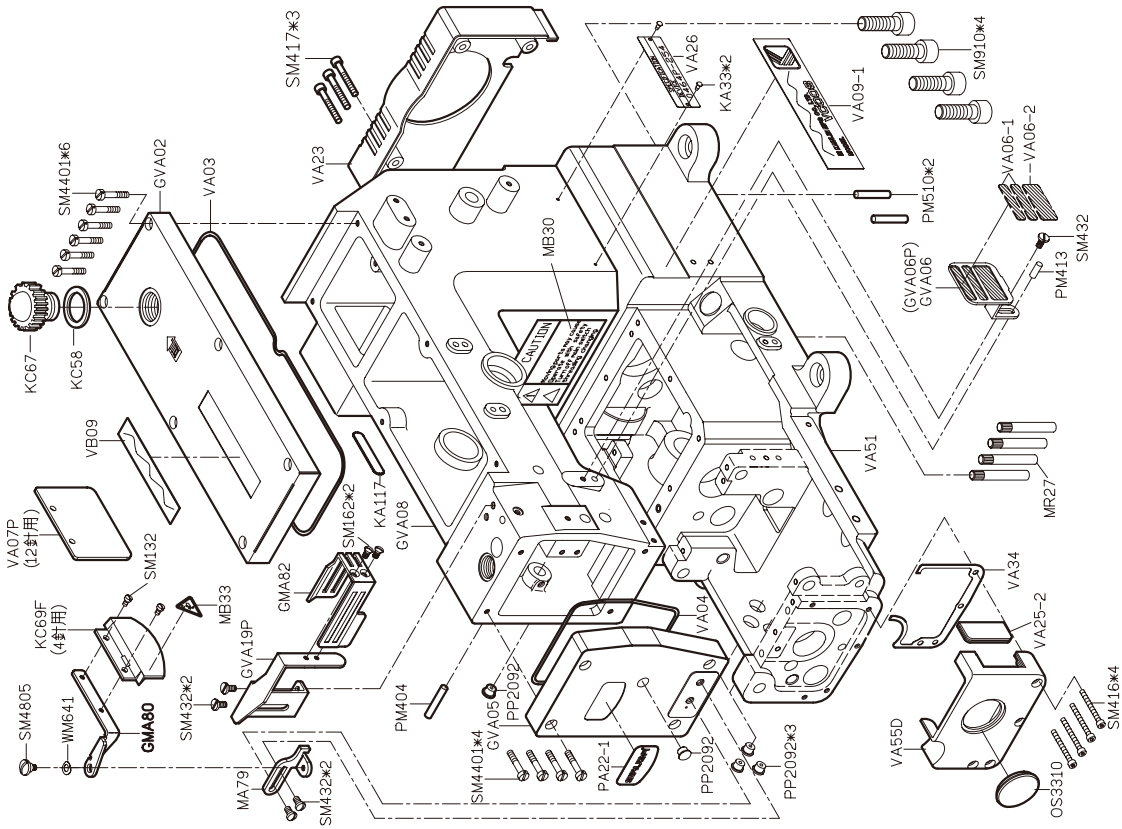
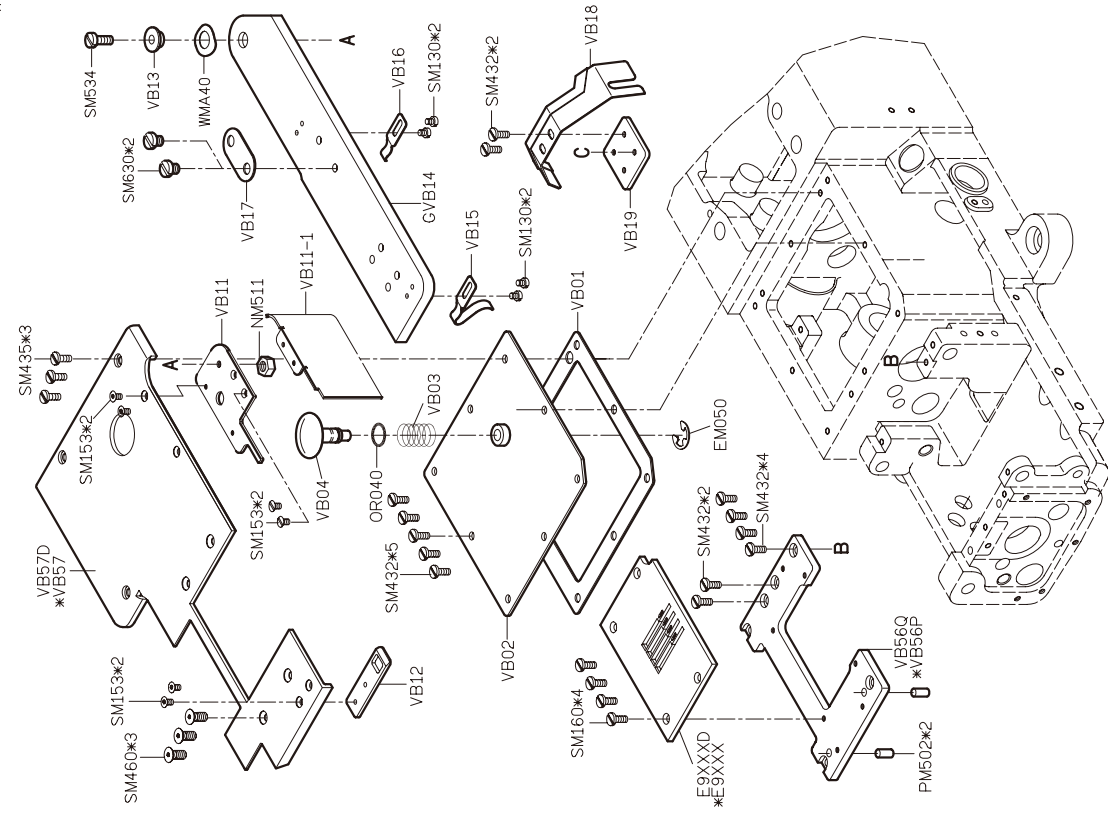

PARTS LIST FOR VA GROUP

PARTS LIST FOR VB GROUP

PARTS LIST FOR VC GROUP

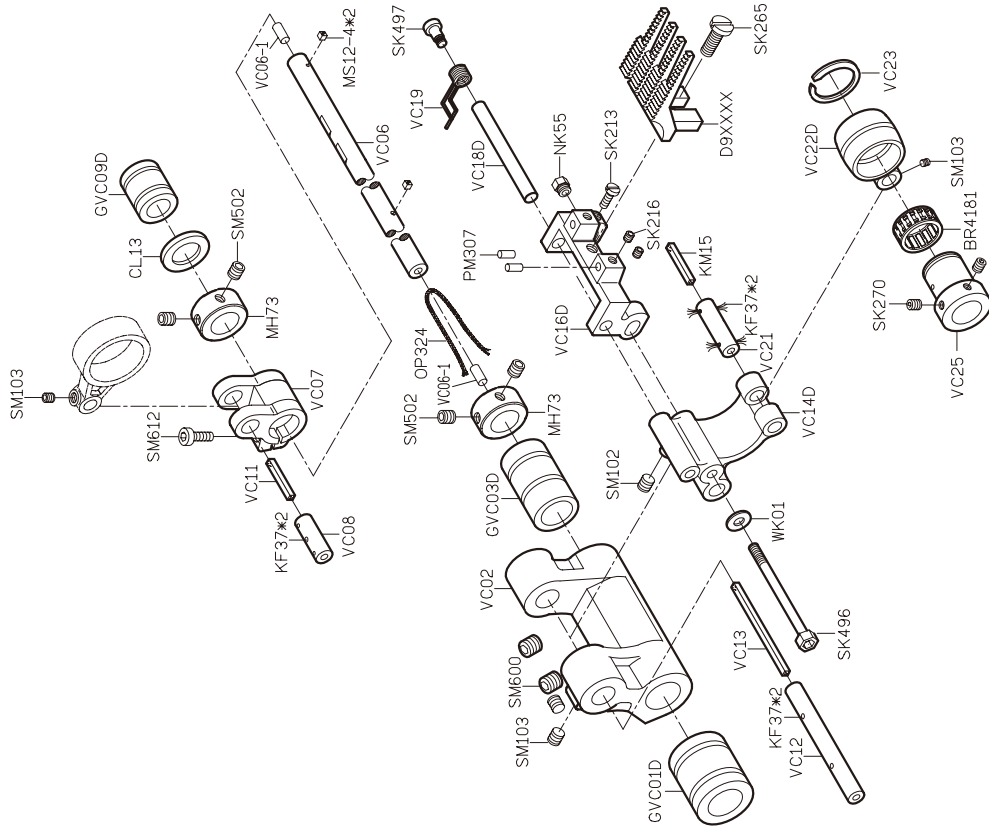

PARTS LIST FOR VD GROUP

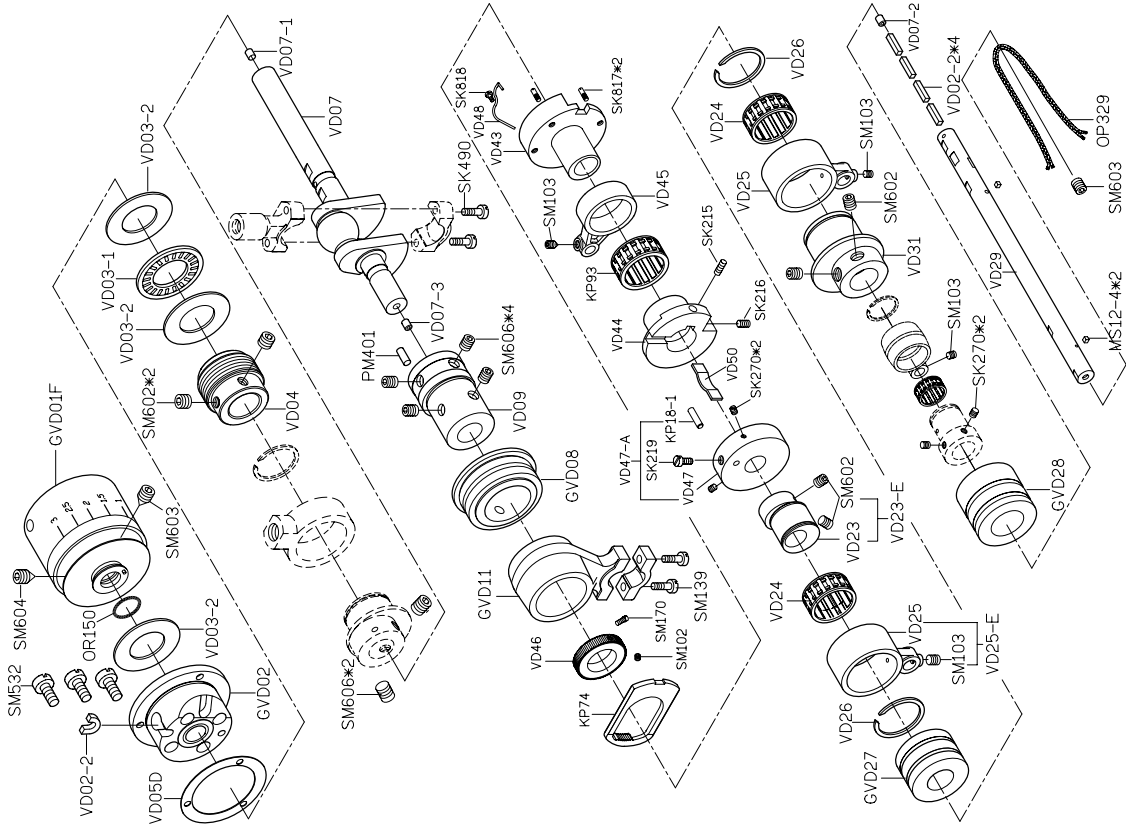

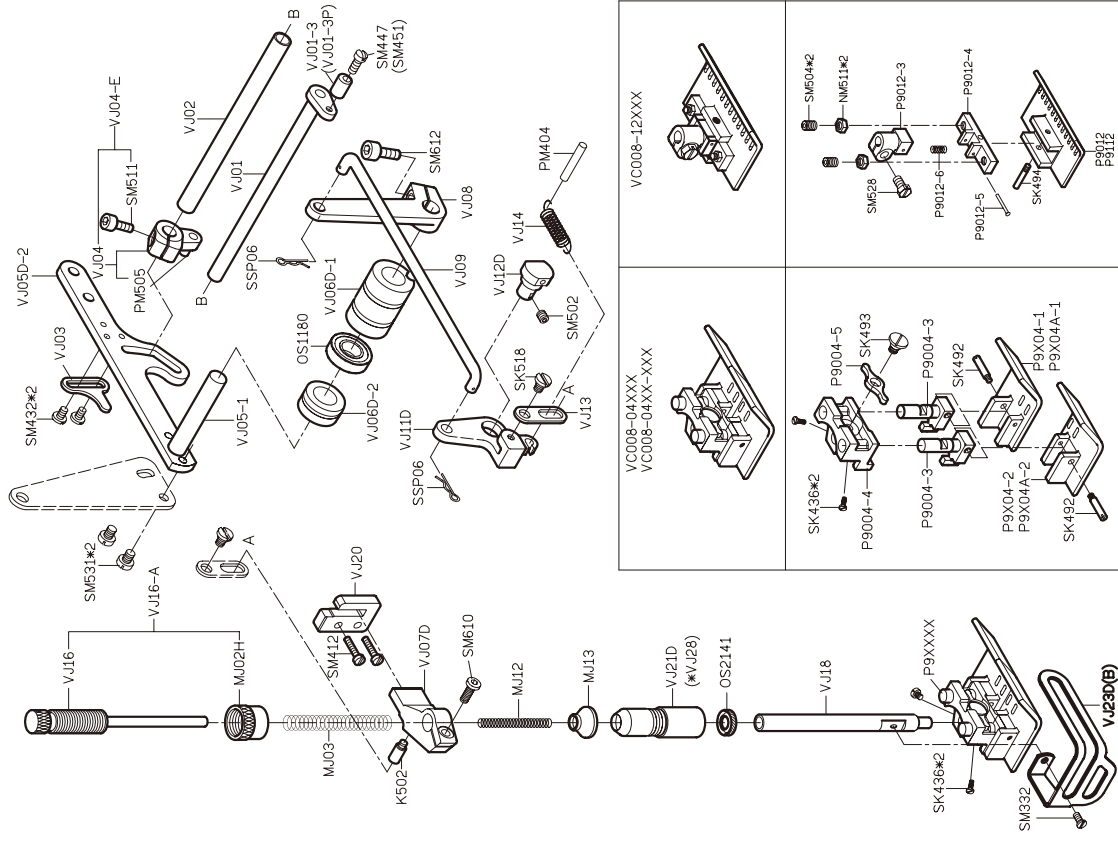
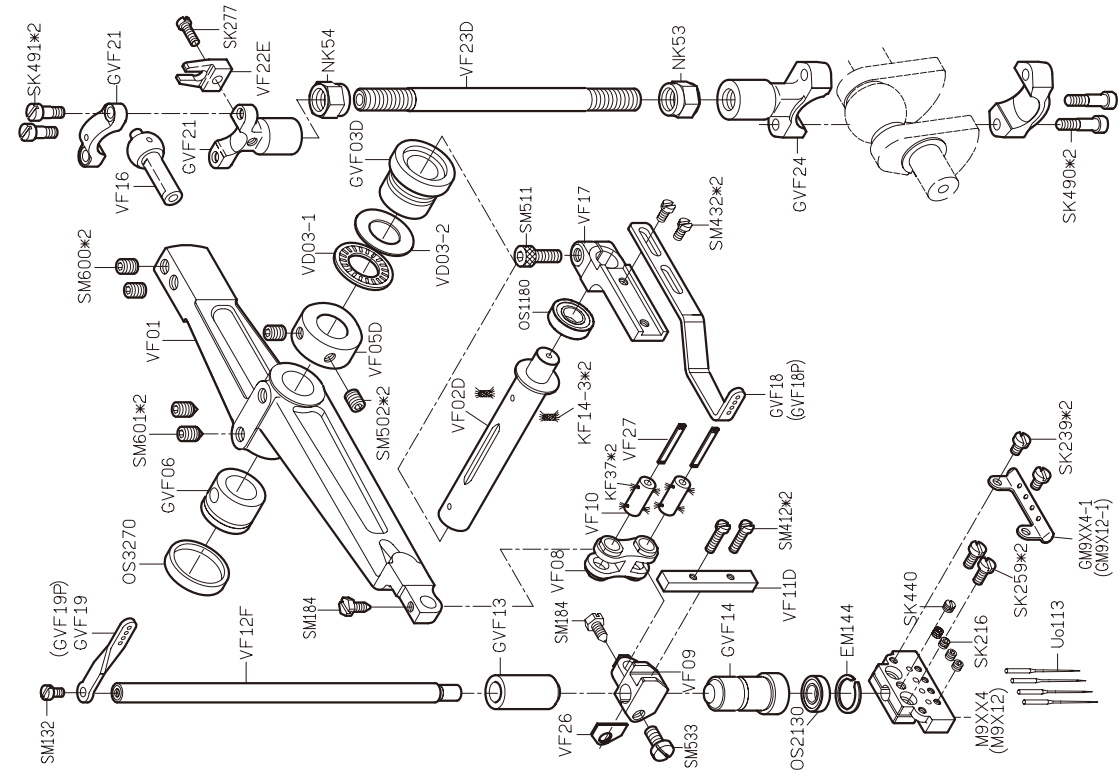

PARTS LIST FOR VF GROUP



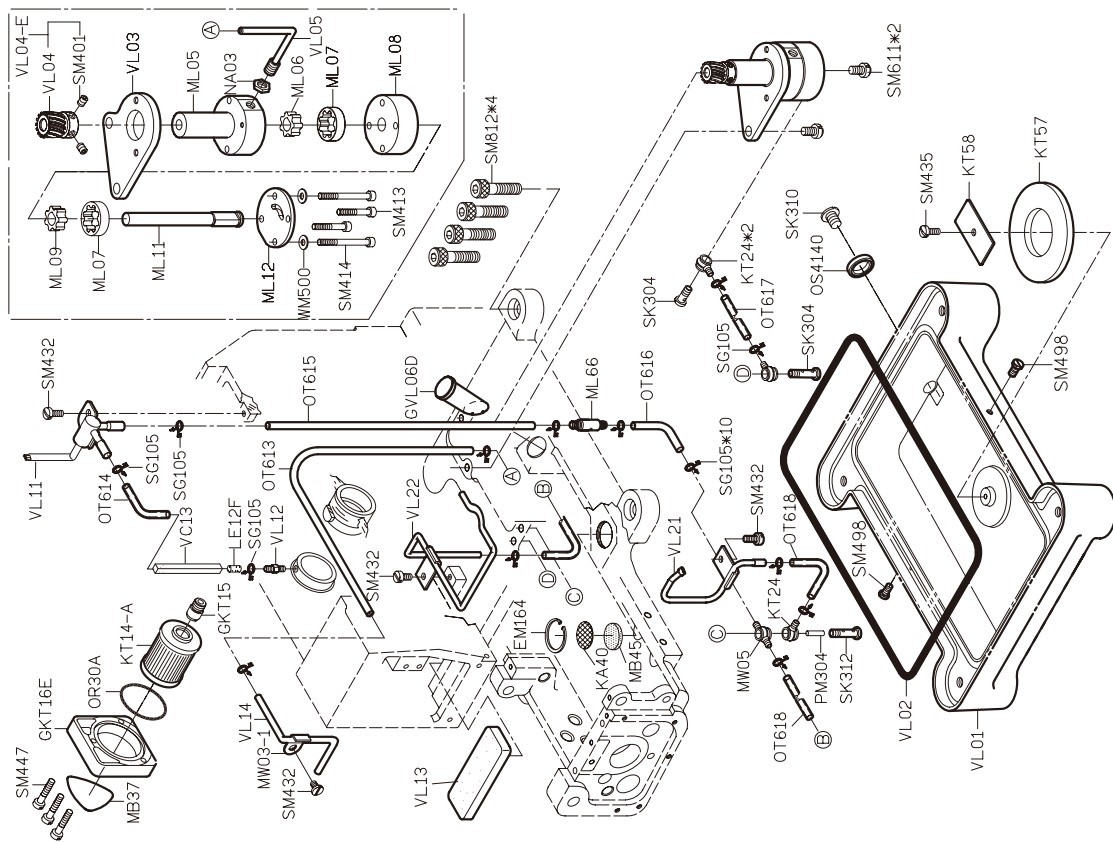
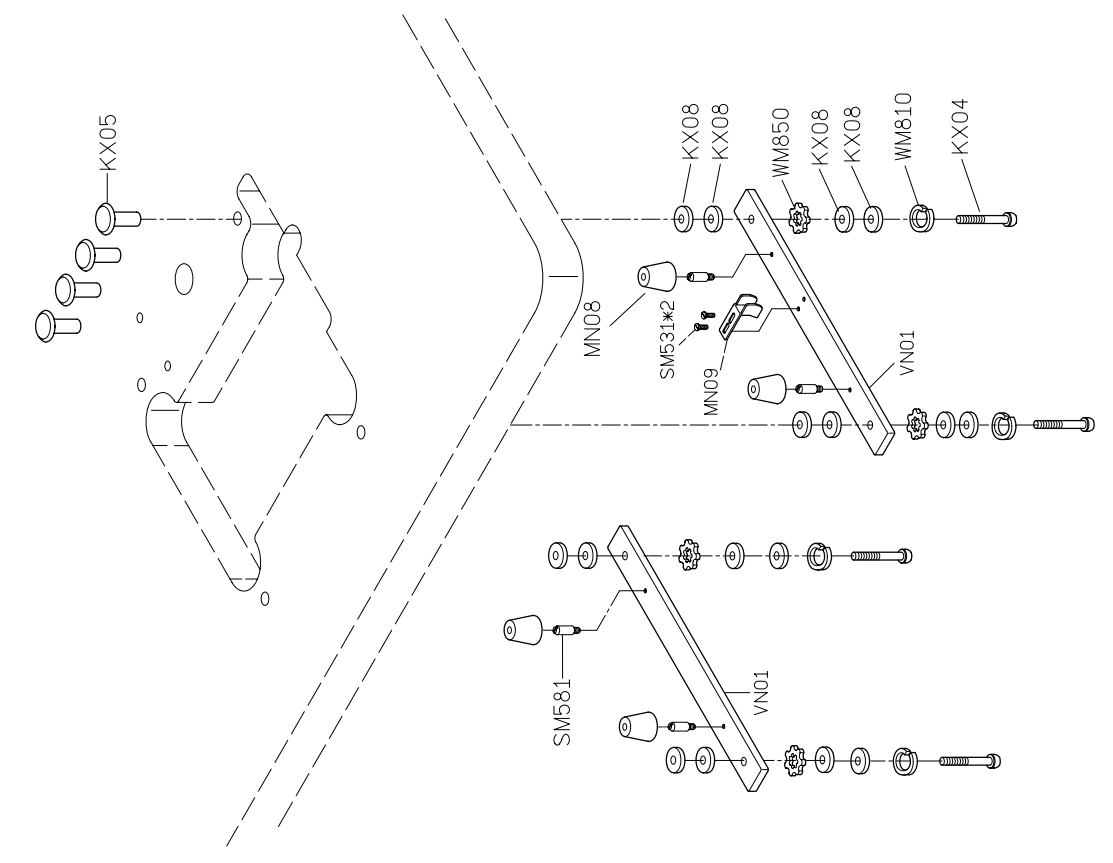





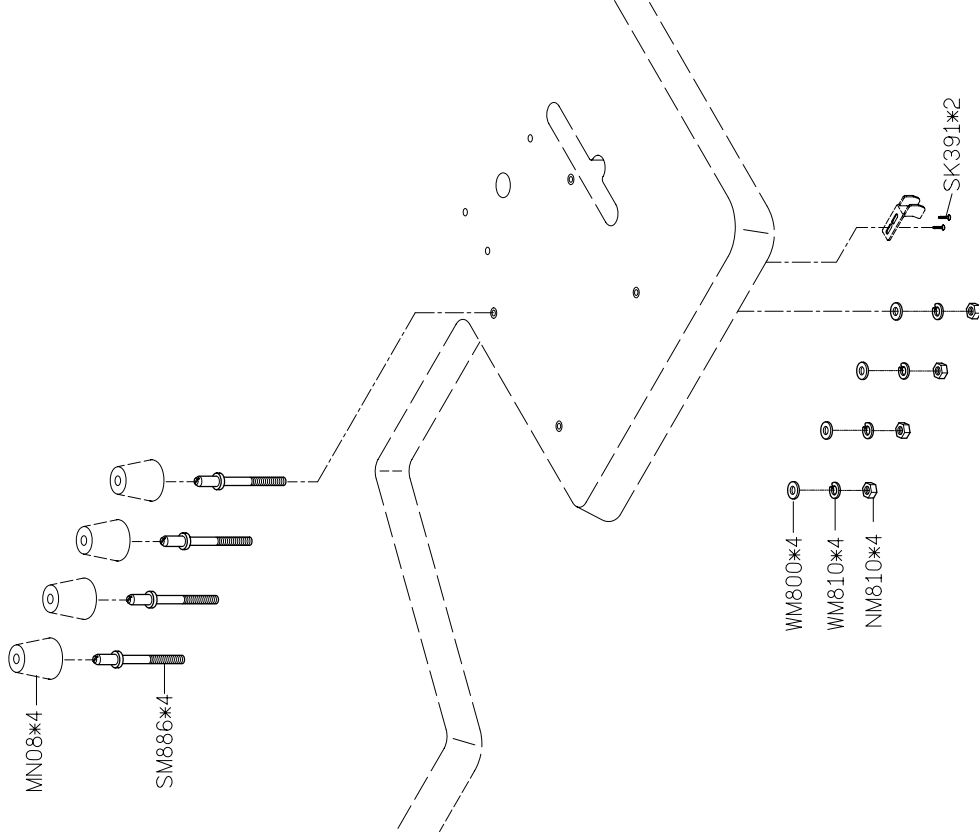

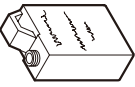











PARTS LIST FOR VJ GROUP

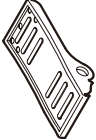

PARTS LIST FOR VN GROUP

PARTS LIST FOR VL GROUP



GMV01 防塵罩 	KY02F-A 油罐 	KY03 油壺 	KY04 漏斗 	KY07 開口板手 
KY08 開口板手 	KY09 開口板手 	MY09 六角板手 	MY10 六角板手 	MY11 六角板手 
MY12 六角板手 	KY11 六角板手 	KY14 內六角螺絲起子 	KY16 一字起子 	KY17 一字起子 
KY18 鑷子 	KY22 一字起子 (23#用) 	KT14-A 濾油器 	GKY26F 工具袋 	針*5 
GKY20D-A 腳踏墊板 	KY21-1/ MY21 鉤子/鍊條 	VY04 零件圖 	VY09 輔助件零件圖 	VY01/P 使用說明書 四針(十二針)車使用說明書 

(4 NEEDLE USE)

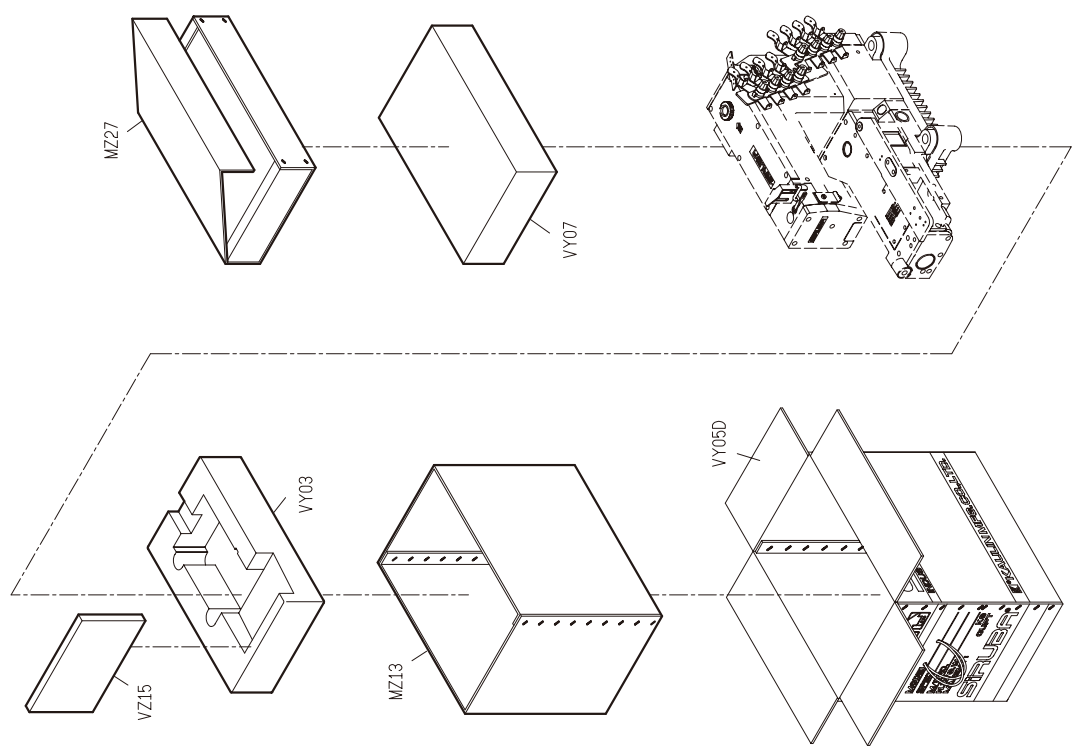
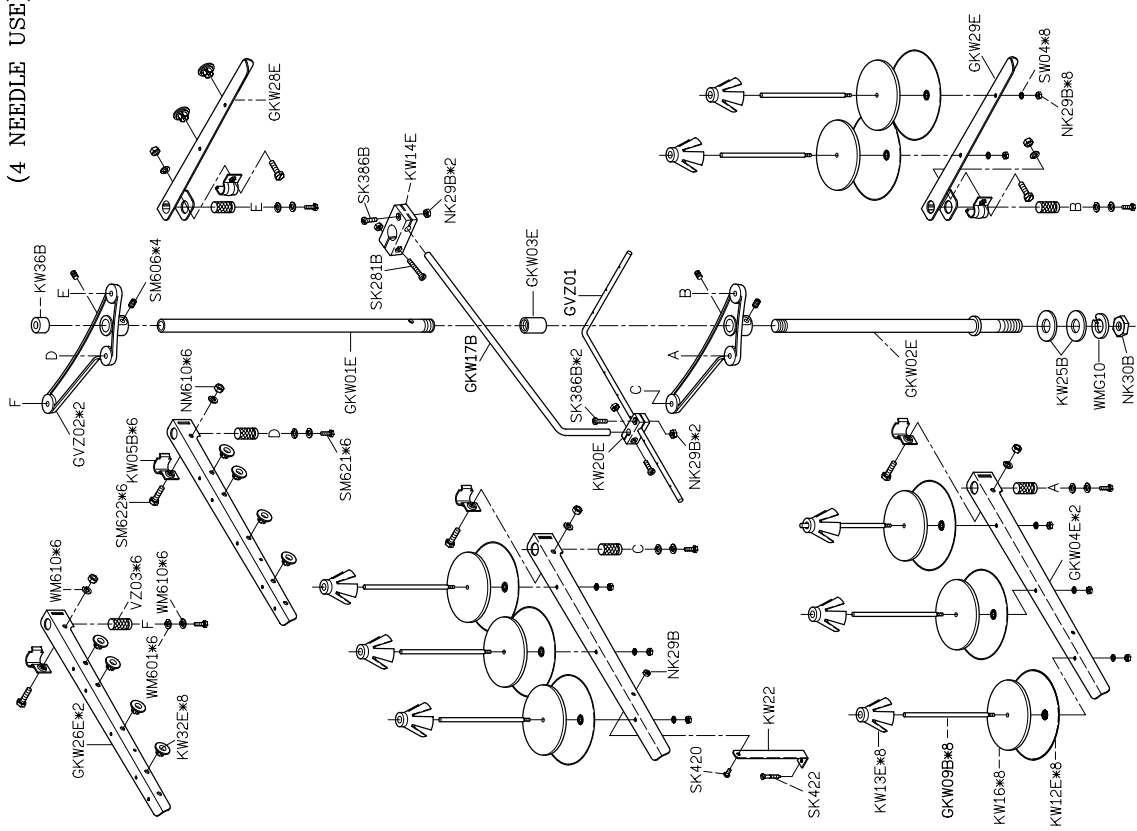

PARTS LIST FOR VY GROUP

PARTS LIST FOR VZ GROUP

PARTS LIST FOR VZ GROUP

PARTS LIST FOR VZ GROUP

(FOR 6~12 NEEDLE USE)

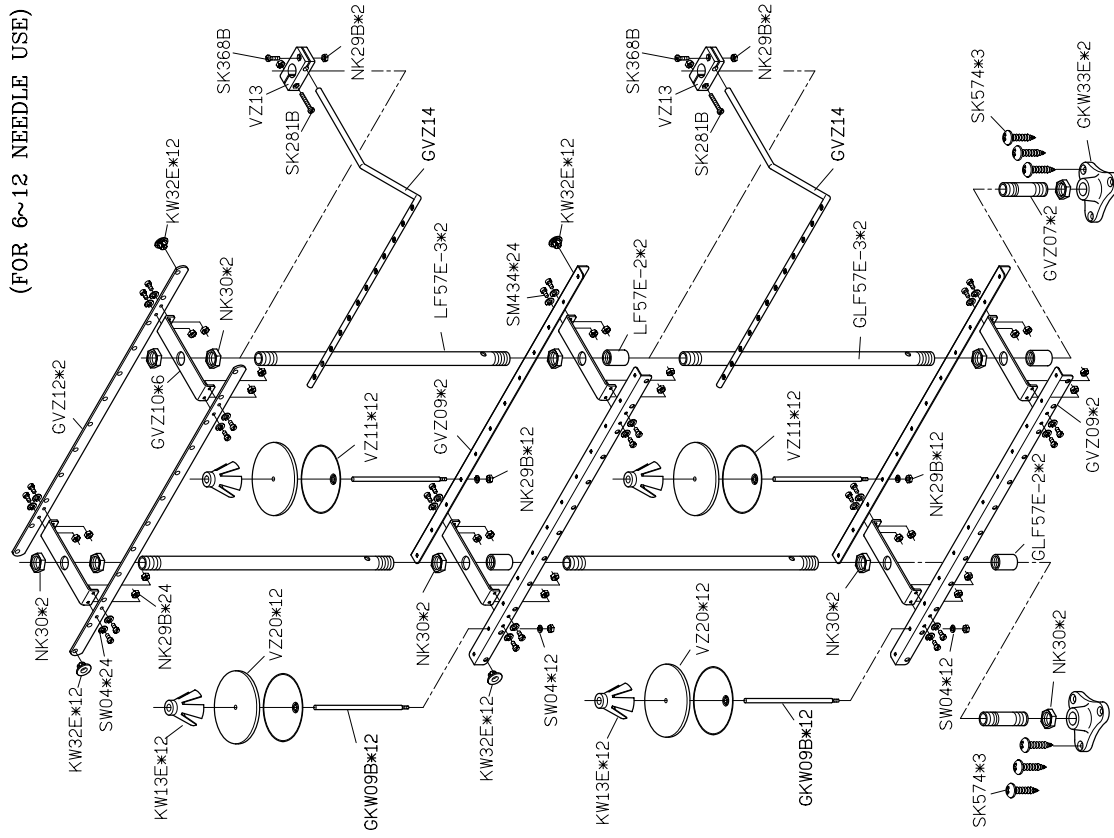

(FOR 12-VPQ NEEDLE USE)

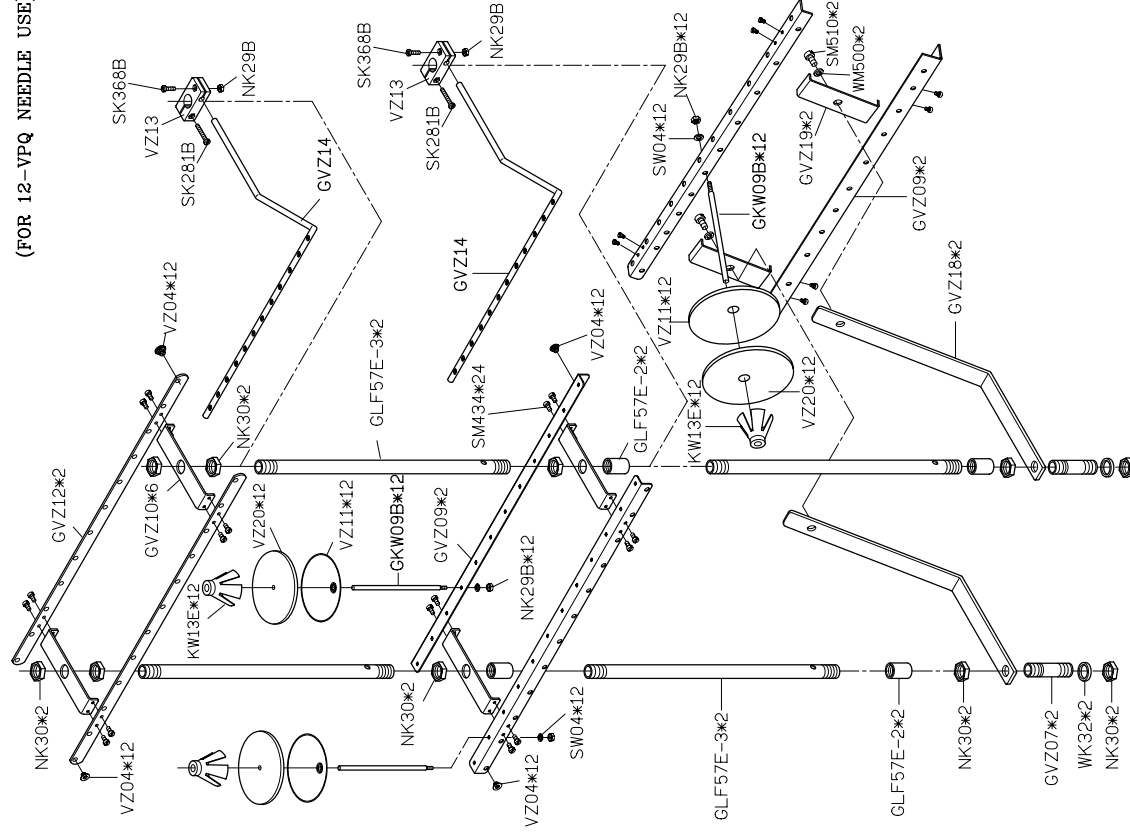



VC008

高林股份有限公司 KAULIN MFG. CO., LTD.